



BEN-YA INDUSTRIAL CO., LTD.

4F, NO.16, LANE 181, SEC.2, JIUZONG ROAD Taipei, Taiwan, R.O.C.

TEL: 886-2-27990822 FAX: 886-2-27978753 e-mail: benya@ms24.hinet.net

MERCEDES BENZ CATALOGUE

Date: 2022/08/30

SEQ.	PHOTO	OEM_NO/ITEM_NO	DESCRIPTION
1		25036979 BZ077BK-TS10	BENZ C200 C280 C36 E300 E320 S320 S420 S500 S600 SL320 E500 S500 L4 L6 V8 WATER TEMPERATURE SENDING UNIT
2		BZM21BK-CR00	BENZ M31.6 CON ROD
3		BZM24BK-CR00	BENZ M62.0 CON ROD
4		BZM24BK-CR01	BENZ M62.3 CON ROD
5		BZL10BK-CR00	BENZ Mazda RUIYI 2.5 CON ROD
6		742693-0001/2 (CHRA) BZ847BK-TCC1	BENZ (OM646) C220 CDI 150HP (05-) 2.2L D TURBOCHARGER CARTRIDGE
7		A642 050 0080 BZ165BK-HVL0	BENZ 1.6L 16VALVE, ENGINE 270.910 HYD. VALVE LIFTER
8		113 050 0080 BZ889BK-HVL0	BENZ 1.7L 8 VALVE ENGINE 266.94 HYD. VALVE LIFTER



BEN-YA INDUSTRIAL CO., LTD.

4F, NO.16, LANE 181, SEC.2, JIUZONG ROAD Taipei, Taiwan, R.O.C.

TEL: 886-2-27990822 FAX: 886-2-27978753 e-mail: benya@ms24.hinet.net

MERCEDES BENZ CATALOGUE

Date: 2022/08/30

SEQ.	PHOTO	OEM_NO/ITEM_NO	DESCRIPTION
9		646 188 0301 BZB85BK-OCL0	BENZ 163.113 (ML270CDI) ENGINE OIL COOLER
10		6965000049 BZ733BK-EXT0	BENZ 1938L, 1634, 1620 EXPANSION TANK
11		A2700521000 BZM15BK-TCN1	BENZ 2.0i TIMING CHAIN TENSIONER
12		6172000720 BZG85BK-WP00	BENZ 207D, 209D3.0, 309D 3.0 WATER PUMP
13		1268300384 BZB77BK-AEVO	BENZ 240/280/300/320 A/C EXPANSION VALVE
14		A2700521400 BZK62BK-TCN0	BENZ 300 TIMING CHAIN TENSIONER
15		A3769970192 BZK04BK-VBT0	BENZ 377 V-BELT
16		6512001370 BZG85BK-TSB0	BENZ A207, C204, C207, C218, R172 TENSIONER BEARING



BEN-YA INDUSTRIAL CO., LTD.

4F, NO.16, LANE 181, SEC.2, JIUZONG ROAD Taipei, Taiwan, R.O.C.

TEL: 886-2-27990822 FAX: 886-2-27978753 e-mail: benya@ms24.hinet.net

MERCEDES BENZ CATALOGUE

Date: 2022/08/30

SEQ.	PHOTO	OEM_NO/ITEM_NO	DESCRIPTION
17		14390N BZ058BK-ATA2	BENZ ALTERNATOR ASSY. (5 Amp/12 Volt , CW, w/o Pulley)
18		620 540 0045 BZ670BK-CNS0	BENZ BM300/356/396/600/613/615/619/620/625/645/64 9/699 COMBINATION SWITCH (LHD)
19		0517452610 BZC14BK-SLR0	BENZ BPW SLACK ADJUSTER
20		0120468143 BZ678BK-ATA0	BENZ BUS ALTERNATOR ASSY.
21		005 545 5224 BZ670BK-TSSA	BENZ BUS 917 TURN SIGNAL SWITCH O/M
22		TK-BE007-B BZB24BK-TMK0	BENZ C180 C200/CGI C230 TIMING KIT
23		BZC31BK-IGC0	BENZ C180 CL203 4CYL 2.0L DOHC 16V M111.951 2001 IGNITION COIL
24		2712000401 BZE94BK-WP00	BENZ C180, C200, W204 CGI WATER PUMP



BEN-YA INDUSTRIAL CO., LTD.

4F, NO.16, LANE 181, SEC.2, JIUZONG ROAD Taipei, Taiwan, R. O. C.

TEL: 886-2-27990822 FAX: 886-2-27978753 e-mail: benya@ms24.hinet.net

MERCEDES BENZ CATALOGUE

Date: 2022/08/30

SEQ.	PHOTO	OEM_NO/ITEM_NO	DESCRIPTION
25		28342997 BZ290BK-CR10	BENZ C200, E200, SPRINTER COMMON RAIL INJECTOR
26		1320340210 BZA51BK-CSG2	BENZ C250 CAMSHAFT GEAR (CAM PHASER)
27		2208300384 BZK32BK-AEVO	BENZ C320 A/C EXPANSION VALVE
28		1122000970 BZ362BK-TSB0	BENZ C320 C240 C43 AMG C280 TENSIONER BEARING
29		2760501447 BZ077BK-CSG1	BENZ C350 E300 E350 CAMSHAFT GEAR (CAM PHASER)
30		2760501347 BZ077BK-CSG0	BENZ C350 E300 E350 CAMSHAFT GEAR (CAM PHASER)
31		2760501647 BZ077BK-CSG3	BENZ C350 E300 E350 CAMSHAFT GEAR (CAM PHASER)
32		2760501547 BZ077BK-CSG2	BENZ C350 E300 E350 CAMSHAFT GEAR (CAM PHASER)



BEN-YA INDUSTRIAL CO., LTD.

4F, NO.16, LANE 181, SEC.2, JIUZONG ROAD Taipei, Taiwan, R.O.C.

TEL: 886-2-27990822 FAX: 886-2-27978753 e-mail: benya@ms24.hinet.net

MERCEDES BENZ CATALOGUE

Date: 2022/08/30

SEQ.	PHOTO	OEM_NO/ITEM_NO	DESCRIPTION
33		A 000 550 0433 BZ058BK-TSB0	BENZ CITARO TENSIONER BEARING
34		2700501247 BZE03BK-CSG1	BENZ CLA250 2014-2016 CAMSHAFT GEAR (CAM PHASER) EXHAUST
35		2700501147 BZE03BK-CSG0	BENZ CLAS250 2014-2016 CAMSHAFT GEAR (CAM PHASER) INTAKE
36		OK0011CP BZL05BK-TMK0	BENZ CLASS A1.6 E 1.9, A-CLASS (W168) A190 TIMING KIT
37		000 234 3111 BZ290BK-ACC0	BENZ CLASS, VITO, SPRINTER (901, 902, 904) AIR CONDITIONER COMPRESSOR
38		0281002927 BZE34BK-FRS0	BENZ CLS FUEL PRESSURE SENSOR
39		2780505200 BZE34BK-CSG3	BENZ CLS550 CAMSHAFT GEAR (CAM PHASER) EXHAUST, LEFT
40		2780505100 BZE34BK-CSG2	BENZ CLS550 CAMSHAFT GEAR (CAM PHASER) EXHAUST, RIGHT



BEN-YA INDUSTRIAL CO., LTD.

4F, NO.16, LANE 181, SEC.2, JIUZONG ROAD Taipei, Taiwan, R.O.C.

TEL: 886-2-27990822 FAX: 886-2-27978753 e-mail: benya@ms24.hinet.net

MERCEDES BENZ CATALOGUE

Date: 2022/08/30

SEQ.	PHOTO	OEM_NO/ITEM_NO	DESCRIPTION
41		2780505000 BZE34BK-CSG1	BENZ CLS550 CAMSHAFT GEAR (CAM PHASER) INTAKE, LEFT
42		2780504900 BZE34BK-CSG0	BENZ CLS550 CAMSHAFT GEAR (CAM PHASER) INTAKE, RIGHT
43		A0011596601 BZI88BK-GLP0	BENZ DIESEL GLOW PLUG
44		611 180 0009 BZ290BK-OFRO	BENZ DODGE SPRINTER 906 OIL FILTER
45		A6112030475 BZ074BK-TMG0	BENZ E200, E220E270, E280, E320 CDI / SPRINTER 311, 313 CDI THERMOSTAT HOUSING
46		611 050 0011 BZB66BK-CHT0	BENZ E270, 2.7D TIMING CHAIN TENSIONER
47		611-050-02-25 BZG61BK-HVL0	BENZ E320 3.2L HYD. VALVE LIFTER
48		11065-AD20A BZK65BK-GLP0	BENZ FRONTIER 2.5 GLOW PLUG



BEN-YA INDUSTRIAL CO., LTD.

4F, NO.16, LANE 181, SEC.2, JIUZONG ROAD Taipei, Taiwan, R.O.C.

TEL: 886-2-27990822 FAX: 886-2-27978753 e-mail: benya@ms24.hinet.net

MERCEDES BENZ CATALOGUE

Date: 2022/08/30

SEQ.	PHOTO	OEM_NO/ITEM_NO	DESCRIPTION
49		BZM25BK-CR01	BENZ HM1.3 CON ROD
50		BZM25BK-CR02	BENZ HM1.5 CON ROD
51		BZM25BK-CR03	BENZ HM2.0 CON ROD
52		BZM25BK-CR00	BENZ HM483 CON ROD
53		71-3842/4 BZ674BK-EB40A	BENZ KLASSE A140/160 M166 C/ROD BEARING 0.25
54		71-3842/4 BZ674BK-EB30	BENZ KLASSE A140/160 M166 C/ROD BEARING STD
55		H065/5 BZ674BK-EB10	BENZ KLASSE A140/160 M166 M/BEARING STD
56		917-241 BZA24BK-VTS0	BENZ L4 121 (2.0L), L6 (3.0L) VARIABLE VALVE TIMING SOLENOID







BEN-YA INDUSTRIAL CO., LTD.

4F, NO.16, LANE 181, SEC.2, JIUZONG ROAD Taipei, Taiwan, R. O. C.

TEL: 886-2-27990822 FAX: 886-2-27978753 e-mail: benya@ms24.hinet.net

MERCEDES BENZ CATALOGUE

Date: 2022/08/30

SEQ.	PHOTO	OEM_NO/ITEM_NO	DESCRIPTION
57		673 540 0545 BZ670BK-CNS2	BENZ LK/LN2, T2/LN1 COMBINATION SWITCH (LHD)
58		673 540 0145 BZ670BK-CNS1	BENZ LK/LN2, T2/LN1 COMBINATION SWITCH (LHD)
59		71-2995/4 BZ849BK-EB30	BENZ M102 ENGINE CON ROD BEARING STD
60		71-3605/4 BZ849BK-EB31	BENZ M102 ENGINE CON ROD BEARING STD
61		71-3817/4 BZB24BK-EB30	BENZ M102, M111.920 (C180) C/R BEARING STD
62		A129/4 BZ850BK-THW0A	BENZ M102/M103/M104/M111 OM601/602/603 THRUST WASHER 0.10mm
63		A129/4 BZ850BK-THW0	BENZ M102/M103/M104/M111 OM601/602/603 THRUST WASHER STD
64		71-3817/6 BZ850BK-EB41A	BENZ M103 ENGINE CON ROD BEARING 0.25



BEN-YA INDUSTRIAL CO., LTD.

4F, NO.16, LANE 181, SEC.2, JIUZONG ROAD Taipei, Taiwan, R.O.C.

TEL: 886-2-27990822 FAX: 886-2-27978753 e-mail: benya@ms24.hinet.net

MERCEDES BENZ CATALOGUE

Date: 2022/08/30

SEQ.	PHOTO	OEM_NO/ITEM_NO	DESCRIPTION
65		71-3605/6 BZ850BK-EB30	BENZ M103 ENGINE CON ROD BEARING STD
66		71-3817/6 BZ850BK-EB31	BENZ M103/M104 ENGINE CON ROD BEARING STD
67		BZ850BK-EB21A	BENZ M103/M104/OM603 MAIN BEARING 0.25
68		H997/7 BZ850BK-EB10	BENZ M103/M104/OM603 MAIN BEARING STD
69		BZ850BK-EB11	BENZ M103/M104/OM603 MAIN BEARING STD
70		71-3817/6 BZB24BK-EB41A	BENZ M104, M111.920 (C180) C/R BEARING 0.25
71		71-3817/6 BZB24BK-EB31	BENZ M104, M111.920 (C180) C/R BEARING STD
72		H069/4 BZB77BK-EB20AA	BENZ M112 (C/E 240/280/320) V6 1997~ MAIN BEARING 0.20



BEN-YA INDUSTRIAL CO., LTD.

4F, NO.16, LANE 181, SEC.2, JIUZONG ROAD Taipei, Taiwan, R.O.C.

TEL: 886-2-27990822 FAX: 886-2-27978753 e-mail: benya@ms24.hinet.net

MERCEDES BENZ CATALOGUE

Date: 2022/08/30

SEQ.	PHOTO	OEM_NO/ITEM_NO	DESCRIPTION
73		H069/4 BZB77BK-EB10	BENZ M112 (C/E 240/280/320) V6 1997~ MAIN BEARING STD
74		71-3857/6 BZB77BK-EB40AA	BENZ M112 (C/E 240/280/320, V6, 18V) CON ROD BEARING 0.20
75		71-3857/6 BZB77BK-EB40A	BENZ M112 (C/E 240/280/320, V6, 18V) CON ROD BEARING 0.25
76		71-3857/6 BZB77BK-EB30	BENZ M112 (C/E 240/280/320, V6, 18V) CON ROD BEARING STD
77		1130500134 BZB85BK-RK21	BENZ M113 ROCKER ARM
78		1130500033 BZB85BK-RK22	BENZ M113 ROCKER ARM
79		1130500133 BZB85BK-RK20	BENZ M113 ROCKER ARM
80		H859/07 BZB78BK-EB10	BENZ M114.920/M130.920 (2.8L, 16V) MAIN BEARING STD





BEN-YA INDUSTRIAL CO., LTD.

4F, NO.16, LANE 181, SEC.2, JIUZONG ROAD Taipei, Taiwan, R.O.C.

TEL: 886-2-27990822 FAX: 886-2-27978753 e-mail: benya@ms24.hinet.net

MERCEDES BENZ CATALOGUE

Date: 2022/08/30

SEQ.	PHOTO	OEM_NO/ITEM_NO	DESCRIPTION
81		71-2773/4 BZ862BK-EB30	BENZ M115 (OM615) CON ROD BEARING STD
82		A1660300062 BZ674BK-THW0	BENZ M166.960 (1.6L) THRUST WASHER
83		A1660300062 BZ674BK-THW0A	BENZ M166.960 (1.6L) THRUST WASHER 0.25
84		BZM22BK-CR00	BENZ M21.3 CON ROD
85		BZM23BK-CR00	BENZ M21.5 CON ROD
86		2760501400 BZB86BK-RK20	BENZ M271 ROCKER ARM
87		A2710503447 BZA51BK-CSG0	BENZ M271 C250 C200 E200 E250 W204 CAMSHAFT GEAR (CAM PHASER) EXHAUST
88		A2710503347 BZA51BK-CSG1	BENZ M271 C250 E250 E200 W204 CAMSHAFT GEAR (CAM PHASER) INTAKE



BEN-YA INDUSTRIAL CO., LTD.

4F, NO.16, LANE 181, SEC.2, JIUZONG ROAD Taipei, Taiwan, R. O. C.

TEL: 886-2-27990822 FAX: 886-2-27978753 e-mail: benya@ms24.hinet.net

MERCEDES BENZ CATALOGUE

Date: 2022/08/30

SEQ.	PHOTO	OEM_NO/ITEM_NO	DESCRIPTION
89		H1002/05 BZB86BK-EB10	BENZ M271.946/M271.948 (1.8L, 16V DOCH) MAIN BEARING STD
90		6110500101 BZB66BK-CMT0S	BENZ M611 CAMSHAFT SEMI without gear (ductile)
91		6460500200 BZB66BK-CMT0A	BENZ M611 CAMSHAFT WITH GEAR
92		6110500101 BZB66BK-CMT0AS	BENZ M611 CAMSHAFT WITH GEAR SEMI
93		6110500101 BZB66BK-CMT0	BENZ M611 CAMSHAFT without gear (ductile)
94		6460500200 BZB66BK-CMT0B	BENZ M611 CAMSHAFT WITH GEAR (CHILLED)
95		BZL49BK-CR00	BENZ MAZDA2.3T CON ROD
96		616 200 07 20 BZC31BK-WP01	BENZ MB 100 (631) to '96+ MB Gclass to '91 WATER PUMP



BEN-YA INDUSTRIAL CO., LTD.

4F, NO.16, LANE 181, SEC.2, JIUZONG ROAD Taipei, Taiwan, R. O. C.

TEL: 886-2-27990822 FAX: 886-2-27978753 e-mail: benya@ms24.hinet.net

MERCEDES BENZ CATALOGUE

Date: 2022/08/30

SEQ.	PHOTO	OEM_NO/ITEM_NO	DESCRIPTION
97		110 200 17 20 BZC31BK-WP00	BENZ MB 230.6 (114.015) WATER PUMP
98		0281002700 BZB66BK-RRS0	BENZ MERCEDES OM611/612 COMMON RAIL FUEL PRESSURE SENSOR
99		A3054210001 BZH89BK-BDM0	BENZ MK BRAKE DRUM
100		A0052508404 BZH89BK-CVA0	BENZ MK CLUTCH COVER ASSEMBLY
101		A0222505903 BZH89BK-CP10	BENZ MK CLUTCH DISK PLATE
102		0022057006 BZH89BK-ENF0	BENZ MK ENGINE FAN
103		002 250 0415 BZH89BK-CRG0	BENZ MK, MB CLUTCH RELEASE BEARING
104		0022057006 BZH89BK-FNB0	BENZ MK, SK FAN BLADE



BEN-YA INDUSTRIAL CO., LTD.

4F, NO.16, LANE 181, SEC.2, JIUZONG ROAD Taipei, Taiwan, R.O.C.

TEL: 886-2-27990822 FAX: 886-2-27978753 e-mail: benya@ms24.hinet.net

MERCEDES BENZ CATALOGUE

Date: 2022/08/30

SEQ.	PHOTO	OEM_NO/ITEM_NO	DESCRIPTION
105		0130111130 BZH89BK-BLM0	BENZ MK/NG BLOWER MOTOR 24V
106		0005012915 BZK48BK-RHC1	BENZ NG SERIES, LK/LN2 RADIATOR HOUSE CAP
107		0005017215 BZK48BK-RHC0	BENZ NG, LP SK RADIATOR HOUSE CAP
108		620 540 0145 BZ670BK-CNS4	BENZ NG/SK/MK COMBINATION SWITCH (RHD)
109		655 540 0145 BZ670BK-CNS3	BENZ NG/SK/MK COMBINATION SWITCH (RHD)
110		3454208338 BZH11BK-SLR0	BENZ OH1318 BRAKE SLACK ADJUSTER REAR (LH)
111		3454208338 BZH11BK-SLR1	BENZ OH1318 BRAKE SLACK ADJUSTER REAR (RH)
112		1020505501 BZ849BK-CMT0	BENZ OM102 CAMSHAFT CHILLED





BEN-YA INDUSTRIAL CO., LTD.

4F, NO.16, LANE 181, SEC.2, JIUZONG ROAD Taipei, Taiwan, R.O.C.

TEL: 886-2-27990822 FAX: 886-2-27978753 e-mail: benya@ms24.hinet.net

MERCEDES BENZ CATALOGUE

Date: 2022/08/30

SEQ.	PHOTO	OEM_NO/ITEM_NO	DESCRIPTION
113		MAHLE 008 48 00 BZJ19BK-PTN0F	BENZ OM137 PISTON/PIN/CLIP ALFIN
114		001WV09 BZ847BK-EL10	BENZ OM601 ENGINE LINER 87mm S/F
115		H997/5 BZ847BK-EB21A	BENZ OM601 MAIN BEARING 0.25
116		H997/5 BZ847BK-EB21B	BENZ OM601 MAIN BEARING 0.50
117		H997/5 BZ847BK-EB11	BENZ OM601 MAIN BEARING STD
118		A129/4 BZ847BK-THW0A	BENZ OM601/602/603/604/605 THRUST WASHER 0.25
119		A129/4 BZ847BK-THW0	BENZ OM601/602/603/604/605 THRUST WASHER STD
120		BZ847BK-PTN0F	BENZ OM601/603, D35A PISTON/PIN/CLIP ALFIN



BEN-YA INDUSTRIAL CO., LTD.

4F, NO.16, LANE 181, SEC.2, JIUZONG ROAD Taipei, Taiwan, R.O.C.

TEL: 886-2-27990822 FAX: 886-2-27978753 e-mail: benya@ms24.hinet.net

MERCEDES BENZ CATALOGUE

Date: 2022/08/30

SEQ.	PHOTO	OEM_NO/ITEM_NO	DESCRIPTION
121		811280436-ES BZ847BK-TCC0	BENZ OM601/606 VITOTURBOCHARGER CARTRIDGE
122		55-3625 BZ847BK-B030	BENZ OM602 CON ROD BUSH
123		78 662 600 BZM18BK-THW0	BENZ OM602 THRUST WASHER
124		A6110104420 BZB66BK-CLH1	BENZ OM611 CYLINDER HEAD ; BARE
125		B40467 BZB66BK-EB30	BENZ OM611 (sprinter 311, 2.3L 16 valve) CON ROD BEARING STD
126		M48661 BZB66BK-EB10	BENZ OM611 (sprinter 311, 2.3L 16 valve) MAIN BEARING STD
127		93138700 BZB66BK-CMTX	BENZ OM611 CAMSHAFT EX
128		93138700 SEMI BZB66BK-CMTXS	BENZ OM611 CAMSHAFT EX SEMI



BEN-YA INDUSTRIAL CO., LTD.

4F, NO.16, LANE 181, SEC.2, JIUZONG ROAD Taipei, Taiwan, R. O. C.

TEL: 886-2-27990822 FAX: 886-2-27978753 e-mail: benya@ms24.hinet.net

MERCEDES BENZ CATALOGUE

Date: 2022/08/30

SEQ.	PHOTO	OEM_NO/ITEM_NO	DESCRIPTION
129		6110500801 BZB66BK-CMTI	BENZ OM611 CAMSHAFT INLET (chilled)
130		6110500801 SEMI BZB66BK-CMTIS	BENZ OM611 CAMSHAFT INLET SEMI
131		1860P40 BZB66BK-EB31	BENZ OM611 DIESEL 2.21 (102-125PS) 75-92KW CON ROD BEARING STD
132		0 433 175 395 BZB66BK-NZL0	BENZ OM611 NOZZLE
133		6110530101 BZ290BK-EV1W	BENZ OM611 SPRINTER CD ENGINE VALVE IN. (30.1*7*104.1)
134		6110500127 BZ290BK-EV1X	BENZ OM611 SPRINTER CD I ENGINE VALVE EX. (28.4*7*104.4)
135		709836-0001/03/04(CHRA) BZB66BK-TCC0	BENZ OM611 Sprinter Van TURBOCHARGER CARTRIDGE
136		6110960699 BZB66BK-TCA0	BENZ OM611 TURBOCHARGER ASSY





BEN-YA INDUSTRIAL CO., LTD.

4F, NO.16, LANE 181, SEC.2, JIUZONG ROAD Taipei, Taiwan, R. O. C.

TEL: 886-2-27990822 FAX: 886-2-27978753 e-mail: benya@ms24.hinet.net

MERCEDES BENZ CATALOGUE

Date: 2022/08/30

SEQ.	PHOTO	OEM_NO/ITEM_NO	DESCRIPTION
137		6110530329 BZB66BK-EV20	BENZ OM611, E270, 2.7D ENGINE VALVE GUIDE
138		346514.12 BZB66BK-HVL0	BENZ OM611/ FIAT FIRE HYD. VALVE LIFTER
139		A6120102020 BZB66BK-CLH2	BENZ OM611/612/613 CYLINDER HEAD ; BARE
140		71-3876/5 BZ041BK-EB40A	BENZ OM611/612/613 (E290, TD2.9) C/R BEARING 0.25
141		71-3876/5 BZ041BK-EB30	BENZ OM611/612/613 (E290, TD2.9) C/R BEARING STD
142		445110189 BZB66BK-CR10	BENZ OM611/612/613, SPRINTER 311/313/412 CDI COMMON RAIL INJECTOR
143		0051516601 BZB66BK-STAO	BENZ OM611LA STARTER MOTOR
144		A0011594801 BZB66BK-GLP0	BENZ OM611LA GLOW PLUG





BEN-YA INDUSTRIAL CO., LTD.

4F, NO.16, LANE 181, SEC.2, JIUZONG ROAD Taipei, Taiwan, R.O.C.

TEL: 886-2-27990822 FAX: 886-2-27978753 e-mail: benya@ms24.hinet.net

MERCEDES BENZ CATALOGUE

Date: 2022/08/30

SEQ.	PHOTO	OEM_NO/ITEM_NO	DESCRIPTION
145		H068/06 BZ041BK-EB10	BENZ OM612 (E290, TD2.9) 5cyls MAIN BEARING STD
146		612-010-23-20 BZ290BK-CLH0	BENZ OM612 2.7L CYLINDER HEAD
147		H796/5 BZ866BK-EB10	BENZ OM615 ENGINE MAIN BEARING STD
148		72-2774H BZ866BK-EB11	BENZ OM615 THRUST BEARING STD
149		55-2532 BZ793BK-B030	BENZ OM616 C/R BUSH SEMI (TIN-BACK)
150		BZ793BK-EL11	BENZ OM616 ENGINE LINER FINISHED
151		001VW04 BZ793BK-EL10	BENZ OM616 ENGINE LINER FINISHED
152		BZ793BK-SAR0	BENZ OM616 SHOCK ABSORBER



BEN-YA INDUSTRIAL CO., LTD.

4F, NO.16, LANE 181, SEC.2, JIUZONG ROAD Taipei, Taiwan, R. O. C.

TEL: 886-2-27990822 FAX: 886-2-27978753 e-mail: benya@ms24.hinet.net

MERCEDES BENZ CATALOGUE

Date: 2022/08/30

SEQ.	PHOTO	OEM_NO/ITEM_NO	DESCRIPTION
153		003 420 0318 BZ793BK-BWC2	BENZ OM616 UNI MOG B/W CYL 13/16"
154		000 586 7303 BZ793BK-BWC3	BENZ OM616 UNI MOG B/W CYLINDER
155		002 420 3718 BZ793BK-BWC1	BENZ OM616 UNI MOG B/W CYLINDER 1 3/8"
156		000 295 3507 BZ793BK-CMC0B	BENZ OM616 UNI MOG C/M CYL LOWER 13/16"
157		001 295 5101 BZ793BK-CMC0A	BENZ OM616 UNI MOG C/M CYL UPPER
158		009 250 5903 BZ793BK-CP10	BENZ OM616 UNI MOG CLUTCH DISK PLATE
159		1 418 862 201 010 BZ793BK-DVA0	BENZ OM616 UNI MOG DELIVERY VALVE
160		H951/5 BZ793BK-EB10	BENZ OM616 UNI MOG MAIN BEARING STD



BEN-YA INDUSTRIAL CO., LTD.

4F, NO.16, LANE 181, SEC.2, JIUZONG ROAD Taipei, Taiwan, R. O. C.

TEL: 886-2-27990822 FAX: 886-2-27978753 e-mail: benya@ms24.hinet.net

MERCEDES BENZ CATALOGUE

Date: 2022/08/30

SEQ.	PHOTO	OEM_NO/ITEM_NO	DESCRIPTION
161		H914/05 BZ793BK-EB11	BENZ OM616 UNI MOG MAIN BEARING STD
162		DN OSD 1510 BZ793BK-NZL0	BENZ OM616 UNI MOG NOZZLE
163		1 418 305 525 BZ793BK-PLG0	BENZ OM616 UNI MOG PLUNGER
164		A113/4 BZ793BK-THW0A	BENZ OM616 UNI MOG THRUST WASHER 0.25
165		A113/4 BZ793BK-THW0B	BENZ OM616 UNI MOG THRUST WASHER 0.50
166		A113/4 BZ793BK-THW0	BENZ OM616 UNI MOG THRUST WASHER STD.
167		8770479050 BZ793BK-PTN0F	BENZ OM616/617-2 PISTON/PIN/CLIP ALFIN STEEL-STRUT
168		A6460100620 BZ027BK-CLH0	BENZ OM646 CYLINDER HEAD ; BARE



BEN-YA INDUSTRIAL CO., LTD.

4F, NO.16, LANE 181, SEC.2, JIUZONG ROAD Taipei, Taiwan, R. O. C.

TEL: 886-2-27990822 FAX: 886-2-27978753 e-mail: benya@ms24.hinet.net

MERCEDES BENZ CATALOGUE

Date: 2022/08/30

SEQ.	PHOTO	OEM_NO/ITEM_NO	DESCRIPTION
169		A6460960199 BZ847BK-TCA0	BENZ OM646 VITO CDI TURBO CHARGER ASSY.
170		6511802601 BZF59BK-OP10	BENZ OM651 OIL PUMP ASSY
171		A6511801310 BZF59BK-OCL0	BENZ OM651 SPRINTER 415/515 OIL COOLER
172		6510103020 BZL52BK-CLH0	BENZ OM651LA CYLINDER HEAD
173		BZJ20BK-PTN0F	BENZ OM901 PISTON/PIN/CLIP ALFIN INNER-COOLING
174		0001802665 BZB83BK-OCL0	BENZ OM904 OIL COOLER
175		904 200 4901 BZB83BK-WP00	BENZ OM904 / OM906 LA WATER PUMP
176		904 016 13 20 BZB83BK-GT31	BENZ OM904, 909/911/922 CYL HEAD GASKET





BEN-YA INDUSTRIAL CO., LTD.

4F, NO.16, LANE 181, SEC.2, JIUZONG ROAD Taipei, Taiwan, R.O.C.

TEL: 886-2-27990822 FAX: 886-2-27978753 e-mail: benya@ms24.hinet.net

MERCEDES BENZ CATALOGUE

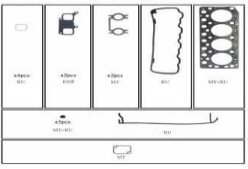
Date: 2022/08/30

SEQ.	PHOTO	OEM_NO/ITEM_NO	DESCRIPTION
177	 <p>OM904, 909/911/922 TAPPET GASKET</p>	A 000 016 0421 BZB83BK-GT10	BENZ OM904, 909/911/922 TAPPET GASKET
178		9060530529 BZB22BK-EV20	BENZ OM904, OM906LA, OM924, OM926 ENGINE VALVE GUIDE
179	 <p>MERCEDES OM904, OM906LA, OM924, OM926</p>	A904 010 6420 BZB83BK-GT41	BENZ OM904/909/911/922 CYL HEAD GASKET KIT
180		9041800965 BZB83BK-OCL1	BENZ OM904LA OIL COOLER
181		9040969199 BZB83BK-TCA0	BENZ OM904LA TURBO CHARGER ASSY
182		71-3850/4 BZB83BK-EB40A	BENZ OM904LA CON ROD BEARING 010
183		71-3850/4 BZB83BK-EB30	BENZ OM904LA CON ROD BEARING STD
184		A9040300660 BZB83BK-EB10	BENZ OM904LA ENGINE MAIN BEARING STD









BEN-YA INDUSTRIAL CO., LTD.

4F, NO.16, LANE 181, SEC.2, JIUZONG ROAD Taipei, Taiwan, R.O.C.

TEL: 886-2-27990822 FAX: 886-2-27978753 e-mail: benya@ms24.hinet.net

MERCEDES BENZ CATALOGUE

Date: 2022/08/30

SEQ.	PHOTO	OEM_NO/ITEM_NO	DESCRIPTION
185		906 053 0132 BZB83BK-EV3X	BENZ OM904LA, OM906, OM926/924 ENGINE VALVE SEAT EX.
186		906 053 0131 BZB83BK-EV3W	BENZ OM904LA, OM906, OM926/924 ENGINE VALVE SEAT IN.
187		906 010 7621 BZB22BK-CLH0	BENZ OM906 CYLINDER HEAD
188		9260300060 BZB22BK-EB31	BENZ OM906 ENGINE CON ROD BEARING STD
189		9260300740 BZB22BK-EB11	BENZ OM906 ENGINE MAIN BEARING STD
190		BZB22BK-GT40	BENZ OM906 GASKET SET
191		1100 210 100 BZB22BK-RK14	BENZ OM906 REPAIR KIT
192		1100 290 100 BZB22BK-RK17	BENZ OM906 REPAIR KIT









BEN-YA INDUSTRIAL CO., LTD.

4F, NO.16, LANE 181, SEC.2, JIUZONG ROAD Taipei, Taiwan, R. O. C.

TEL: 886-2-27990822 FAX: 886-2-27978753 e-mail: benya@ms24.hinet.net

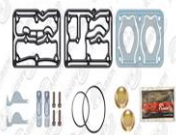
MERCEDES BENZ CATALOGUE

Date: 2022/08/30

SEQ.	PHOTO	OEM_NO/ITEM_NO	DESCRIPTION
193		1100 200 100 BZB22BK-RK13	BENZ OM906 REPAIR KIT
194		1100 015 100 BZB22BK-RK10	BENZ OM906 REPAIR KIT
195		1100 220 100 BZB22BK-RK15	BENZ OM906 REPAIR KIT
196		1100 225 100 BZB22BK-RK16	BENZ OM906 REPAIR KIT
197		1100 040 100 BZB22BK-RK11	BENZ OM906 REPAIR KIT
198		1100 045 100 BZB22BK-RK12	BENZ OM906 REPAIR KIT
199		53279887120 BZB22BK-TCA1	BENZ OM906 TURBO CHARGER ASSY
200		A9069934396 BZB22BK-VBT0	BENZ OM906 V-BELT



BEN-YA INDUSTRIAL CO., LTD.

4F, NO.16, LANE 181, SEC.2, JIUZONG ROAD Taipei, Taiwan, R.O.C.

TEL: 886-2-27990822 FAX: 886-2-27978753 e-mail: benya@ms24.hinet.net

MERCEDES BENZ CATALOGUE

Date: 2022/08/30

SEQ.	PHOTO	OEM_NO/ITEM_NO	DESCRIPTION
201		A9042002501 BZB22BK-WP00	BENZ OM906 WATER PUMP
202		A906 130 12 15 BZB22BK-ACS0	BENZ OM906 AIR COMPRESSOR
203		906 016 11 20 BZB22BK-GT30	BENZ OM906 CYL HEAD GASKET
204		71-3850/6 BZB22BK-EB30	BENZ OM906 ENGINE CON ROD BEARING STD
205		H067/7 BZB22BK-EB10	BENZ OM906 ENGINE MAIN BEARING STD
206		BZB22BK-GT70	BENZ OM906 GASKET HEAD SET
207		A9061300615 BZB22BK-ACS1	BENZ OM906 OM904 AIR COMPRESSOR
208		9062000670 BZB22BK-TSB3	BENZ OM906 TENSIONER BEARING





BEN-YA INDUSTRIAL CO., LTD.

4F, NO.16, LANE 181, SEC.2, JIUZONG ROAD Taipei, Taiwan, R. O. C.

TEL: 886-2-27990822 FAX: 886-2-27978753 e-mail: benya@ms24.hinet.net

MERCEDES BENZ CATALOGUE

Date: 2022/08/30

SEQ.	PHOTO	OEM_NO/ITEM_NO	DESCRIPTION
209		79 228 600 BZB22BK-THW0	BENZ OM906 THRUST WASHER
210		906.180.0601 BZB22BK-OP10	BENZ OM906, OM904, OM924, OM926 OIL PUMP ASSY
211		906 016 08 20 BZB22BK-GT32	BENZ OM906, OM909, OM919, OM921 CYL HEAD GASKET SET (STEEL)
212		906 016 14 20 BZB22BK-GT31	BENZ OM906, OM909, OM919, OM921 CYL HEAD GASKET SET (STEEL)
213		A906 017 0488 BZB22BK-IJS0	BENZ OM906/OM904 LA/HLA INJECTOR SLEEVE
214		53279707120 BZB22BK-TCA0	BENZ OM906LA TURBO CHARGER ASSY
215		BZB22BK-GT41	BENZ OM909 CYL HEAD GASKET KIT
216		BZL58BK-CBK0	BENZ OM924 CYL. BLOCK



BEN-YA INDUSTRIAL CO., LTD.

4F, NO.16, LANE 181, SEC.2, JIUZONG ROAD Taipei, Taiwan, R.O.C.

TEL: 886-2-27990822 FAX: 886-2-27978753 e-mail: benya@ms24.hinet.net

MERCEDES BENZ CATALOGUE

Date: 2022/08/30

SEQ.	PHOTO	OEM_NO/ITEM_NO	DESCRIPTION
217		DSL156P1412 BZB22BK-NZL0	BENZ OM924 NOZZLE
218		92601600820 BZL59BK-GT30	BENZ OM926 CYL HEAD GASKET
219		926 010 08 05 BZL59BK-CBK0	BENZ OM926 CYL. BLOCK
220		9060108221 BZL59BK-CLH0	BENZ OM926LA, OM906LA CYLINDER HEAD
221		602 200 02 20 BZC31BK-WP02	BENZ PASSANGER CAR WATER PUMP
222		0281002535 BZC31BK-AFM0	BENZ PASSENGER CAR AIR FLOW METER
223		2720500033 BZC31BK-RK20	BENZ PASSENGER CAR C230 C280 C300 E350 ROCKER ARM
224		F 000 401 069 F 000 401 069	BENZ PES6P 120A720LS7257-11 PLUNGER







BEN-YA INDUSTRIAL CO., LTD.

4F, NO.16, LANE 181, SEC.2, JIUZONG ROAD Taipei, Taiwan, R. O. C.

TEL: 886-2-27990822 FAX: 886-2-27978753 e-mail: benya@ms24.hinet.net

MERCEDES BENZ CATALOGUE

Date: 2022/08/30

SEQ.	PHOTO	OEM_NO/ITEM_NO	DESCRIPTION
225		901 880 0670 BZA66BK-FBU0	BENZ PREMIUM FRONT BUMPER
226		6420907737 BZD74BK-RK10	BENZ R320 ED320 OM642 REPAIR KIT
227		002 323 5300 BZ058BK-SAR2	BENZ SHOCK ABSORBER
228		1862 138 032 BZ670BK-CP10	BENZ SK, MK, NG SERIES CLUTCH DISK PLATE
229		1220500080 BZC55BK-HVL0	BENZ SMART HYD. VALVE LIFTER
230		901-333-0727 BZ290BK-BJT0	BENZ SPRINTER BALL JOINT
231		9063304107 BZ290BK-CTAC	BENZ SPRINTER CONTROL ARM RH W/BALL JOINT
232		000 477 9215 BZ290BK-FFE0	BENZ SPRINTER FUEL FILTER



BEN-YA INDUSTRIAL CO., LTD.

4F, NO.16, LANE 181, SEC.2, JIUZONG ROAD Taipei, Taiwan, R. O. C.

TEL: 886-2-27990822 FAX: 886-2-27978753 e-mail: benya@ms24.hinet.net

MERCEDES BENZ CATALOGUE

Date: 2022/08/30

SEQ.	PHOTO	OEM_NO/ITEM_NO	DESCRIPTION
233		000 466 0604 BZ290BK-OFEO	BENZ SPRINTER OIL FILTER ELEMENT
234		149971792A BZ290BK-PKB0	BENZ SPRINTER PK BELT
235		9043201930 BZ290BK-SAR0I	BENZ SPRINTER SHOCK ABSORBER FRONT
236		9014604100 BZ290BK-SGR0	BENZ SPRINTER STEERING GEAR
237		BZ290BK-R000	BENZ SPRINTER WINDOW REGULATOR ASSY
238		445115068 BZ290BK-CRI1	BENZ SPRINTER 2.1 CDI COMMON RAIL INJECTOR
239		651050080 BZ290BK-HVL1	BENZ SPRINTER 2.2 CDI HYD. VALVE LIFTER WITH PROTECTION COVER
240		651050080 BZ290BK-HVL0	BENZ SPRINTER 2.2 CDI HYD. VALVE LIFTER WITHOUT PROTECTION COVER





BEN-YA INDUSTRIAL CO., LTD.

4F, NO.16, LANE 181, SEC.2, JIUZONG ROAD Taipei, Taiwan, R.O.C.

TEL: 886-2-27990822 FAX: 886-2-27978753 e-mail: benya@ms24.hinet.net

MERCEDES BENZ CATALOGUE

Date: 2022/08/30

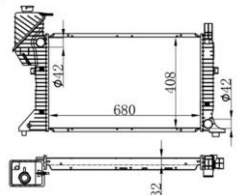
SEQ.	PHOTO	OEM_NO/ITEM_NO	DESCRIPTION
241		A6120960399 BZ290BK-TCA0	BENZ SPRINTER 2.7L GT2256V (OM612) TURBO CHARGER ASSY
242		A6120960399 (CHAR) BZ290BK-TCC0	BENZ SPRINTER 2.7L GT2256V (OM612) TURBO CHARGER CARTRIDGE
243		6011801401 BZ290BK-OP10	BENZ SPRINTER 208, 211, 316 CDI, 408 CDI OIL PUMP ASSY
244		6010500801 BZ290BK-CMT1	BENZ SPRINTER 310 CAMSHAFT
245		6010500801 BZ290BK-CMT1S	BENZ SPRINTER 310 CAMSHAFT SEMI (CASTING)
246		611-050-08-01 BZ290BK-CMT0	BENZ SPRINTER 310, VITO BUS CAMSHAFT (CASTING)
247		NT-4079.136 BZ290BK-RDT3	BENZ SPRINTER 310/312 RADIATOR
248		9015003300 BZ290BK-RDT0	BENZ SPRINTER 310/312 RADIATOR







BEN-YA INDUSTRIAL CO., LTD.

4F, NO.16, LANE 181, SEC.2, JIUZONG ROAD Taipei, Taiwan, R. O. C.

TEL: 886-2-27990822 FAX: 886-2-27978753 e-mail: benya@ms24.hinet.net

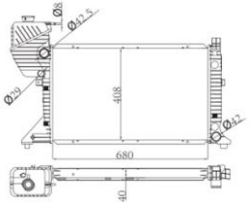
MERCEDES BENZ CATALOGUE

Date: 2022/08/30

SEQ.	PHOTO	OEM_NO/ITEM_NO	DESCRIPTION
249		11605900001 BZ290BK-RDT2	BENZ SPRINTER 311/313 CDI RADIATOR
250		6512001870 BZ290BK-TSB3	BENZ SPRINTER 311/313/415/515, OM612 TENSIONER BEARING
251		9015003600 BZ290BK-RDT1	BENZ SPRINTER 313 CDI RADIATOR
252		901 320 0631 BZ290BK-SAR5	BENZ SPRINTER 313 SHOCK ABSORBER
253		A9064200320 BZB66BK-BS10	BENZ SPRINTER 415/515 BRAKE SHOES
254		6511800665 BZ290BK-OCL0	BENZ SPRINTER 415/515 OIL COOLER
255		65120-02301 BZ290BK-WP00	BENZ SPRINTER 415/515 CDI 2.2L 16V, OM651 WATER PUMP
256		65120-02301 housing BZ290BK-WP00H	BENZ SPRINTER 415/515 CDI 2.2L 16V, OM651 WATER PUMP HOUSING



BEN-YA INDUSTRIAL CO., LTD.

4F, NO.16, LANE 181, SEC.2, JIUZONG ROAD Taipei, Taiwan, R. O. C.

TEL: 886-2-27990822 FAX: 886-2-27978753 e-mail: benya@ms24.hinet.net

MERCEDES BENZ CATALOGUE

Date: 2022/08/30

SEQ.	PHOTO	OEM_NO/ITEM_NO	DESCRIPTION
257		000 835 6107 BZ290BK-BLM2	BENZ SPRINTER 906 BLOWER MOTOR (INTERIOR FAN)
258		000 835 6007 BZ290BK-BLM3	BENZ SPRINTER 906 BLOWER MOTOR (INTERIOR FAN)
259		9064210012 BZ290BK-BDCI	BENZ SPRINTER 906 BRAKE DISC FRONT
260		004 420 6920 BZ290BK-BDP0J	BENZ SPRINTER 906 BRAKE DISC PAD REAR
261		9064230012 BZ290BK-BDCJ	BENZ SPRINTER 906 BRAKE DISC REAR
262		9064230112 BZ290BK-BDC0	BENZ SPRINTER 906 BRAKE DISC REAR
263		906 420 0320 BZ290BK-BS10	BENZ SPRINTER 906 BRAKE SHOES
264		9068850011 BZ290BK-BPC0	BENZ SPRINTER 906 BUMPER CENTER



BEN-YA INDUSTRIAL CO., LTD.

4F, NO.16, LANE 181, SEC.2, JIUZONG ROAD Taipei, Taiwan, R.O.C.

TEL: 886-2-27990822 FAX: 886-2-27978753 e-mail: benya@ms24.hinet.net

MERCEDES BENZ CATALOGUE

Date: 2022/08/30

SEQ.	PHOTO	OEM_NO/ITEM_NO	DESCRIPTION
265		9067400216 BZ290BK-DCK0	BENZ SPRINTER 906 DOOR CHECK
266		9067601228 BZ290BK-DCK0A	BENZ SPRINTER 906 DOOR CHECK
267		9067600070 BZ290BK-DOHD	BENZ SPRINTER 906 DOOR HANDLE LH
268		9067600170 BZ290BK-DOHC	BENZ SPRINTER 906 DOOR HANDLE RH
269		9067600547 BZ290BK-DSL0	BENZ SPRINTER 906 DOOR SLIDE LEVEL
270		2118200556 BZ290BK-FOLD	BENZ SPRINTER 906 FOG LAMP LH
271		211 820 0656 BZ290BK-FOLC	BENZ SPRINTER 906 FOG LAMP RH
272		9068820004 BZ290BK-FMGD	BENZ SPRINTER 906 FRONT MUDGUARD LH



BEN-YA INDUSTRIAL CO., LTD.

4F, NO.16, LANE 181, SEC.2, JIUZONG ROAD Taipei, Taiwan, R.O.C.

TEL: 886-2-27990822 FAX: 886-2-27978753 e-mail: benya@ms24.hinet.net

MERCEDES BENZ CATALOGUE

Date: 2022/08/30

SEQ.	PHOTO	OEM_NO/ITEM_NO	DESCRIPTION
273		9068820104 BZ290BK-FMGC	BENZ SPRINTER 906 FRONT MUDGUARD RH
274		9068821014 BZ290BK-BRKD	BENZ SPRINTER 906 HAND BRACKET LH
275		9068821114 BZ290BK-BRKC	BENZ SPRINTER 906 HAND BRACKET RH
276		9068200661 BZ290BK-HLPD	BENZ SPRINTER 906 HEAD LAMP ELECTRICAL LH
277		9068200561 BZ290BK-HLPC	BENZ SPRINTER 906 HEAD LAMP ELECTRICAL RH
278		9068260040 BZ290BK-HLFD	BENZ SPRINTER 906 HEAD LAMP REFLECTOR LH
279		9068260140 BZ290BK-HLFC	BENZ SPRINTER 906 HEAD LAMP REFLECTOR RH
280		2712060019 BZ290BK-IDPO	BENZ SPRINTER 906 IDLER PULLEYS



BEN-YA INDUSTRIAL CO., LTD.

4F, NO.16, LANE 181, SEC.2, JIUZONG ROAD Taipei, Taiwan, R. O. C.

TEL: 886-2-27990822 FAX: 886-2-27978753 e-mail: benya@ms24.hinet.net

MERCEDES BENZ CATALOGUE

Date: 2022/08/30

SEQ.	PHOTO	OEM_NO/ITEM_NO	DESCRIPTION
281		9068104816 BZ290BK-MR0D	BENZ SPRINTER 906 MIRROR ASSY ELECTRICAL LH
282		9068104916 BZ290BK-MR0C	BENZ SPRINTER 906 MIRROR ASSY ELECTRICAL RH
283		003 466 7201 BZ290BK-PSP0	BENZ SPRINTER 906 POWER STEERING PUMP
284		9068800385 BZ290BK-GR10	BENZ SPRINTER 906 RADIATOR GRILLE
285		9068801071 BZ290BK-RBUD	BENZ SPRINTER 906 REAR BUMPER LH
286		9068801171 BZ290BK-RBUC	BENZ SPRINTER 906 REAR BUMPER RH
287		9068820604 BZ290BK-RMGD	BENZ SPRINTER 906 REAR MUDGUARD LH
288		9068820704 BZ290BK-RMGC	BENZ SPRINTER 906 REAR MUDGUARD RH









BEN-YA INDUSTRIAL CO., LTD.

4F, NO.16, LANE 181, SEC.2, JIUZONG ROAD Taipei, Taiwan, R.O.C.

TEL: 886-2-27990822 FAX: 886-2-27978753 e-mail: benya@ms24.hinet.net

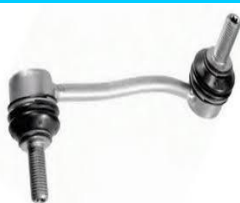
MERCEDES BENZ CATALOGUE

Date: 2022/08/30

SEQ.	PHOTO	OEM_NO/ITEM_NO	DESCRIPTION
289		906 326 0800 BZ290BK-SAR3	BENZ SPRINTER 906 SHOCK ABSORBER REAR
290		9068103293 BZ290BK-SMRD	BENZ SPRINTER 906 SIDE MIRROR ELECTRICAL LH
291		9068103393 BZ290BK-SMRC	BENZ SPRINTER 906 SIDE MIRROR ELECTRICAL RH
292		906 320 1889 BZ290BK-SLK0	BENZ SPRINTER 906 STEER LINK (stabilizer bar)
293		9068200464 BZ290BK-LP2DA	BENZ SPRINTER 906 TAIL LAMP LH
294		9068201764 BZ290BK-LP2CA	BENZ SPRINTER 906 TAIL LAMP RH
295		9068200164 BZ290BK-LP2D	BENZ SPRINTER 906 TAIL LAMP WITH CABLE LH
296		9068200264 BZ290BK-LP2C	BENZ SPRINTER 906 TAIL LAMP WITH CABLE RH



BEN-YA INDUSTRIAL CO., LTD.

4F, NO.16, LANE 181, SEC.2, JIUZONG ROAD Taipei, Taiwan, R. O. C.

TEL: 886-2-27990822 FAX: 886-2-27978753 e-mail: benya@ms24.hinet.net

MERCEDES BENZ CATALOGUE

Date: 2022/08/30

SEQ.	PHOTO	OEM_NO/ITEM_NO	DESCRIPTION
297		9067600147 BZ290BK-ROG0UP	BENZ SPRINTER 906 UPPER ROLLER GUIDE SLIDING DOOR
298		9064010025 BZ290BK-WHB0	BENZ SPRINTER 906 WHEEL HUB
299		2E0 413 023AH BZ290BK-SAR0	BENZ SPRINTER 906 (3.5T) SHOCK ABSORBER
300		906 320 6230 BZ290BK-SAR2	BENZ SPRINTER 906 (3.5T, BUS) SHOCK ABSORBER
301		906 320 0031 BZ290BK-SAR1	BENZ SPRINTER 906 (3.5T, BUT) SHOCK ABSORBER
302		906 326 0600 BZ290BK-SAR4	BENZ SPRINTER 906 (4.6T) SHOCK ABSORBER
303		000 993 0676 BZ290BK-TCN0	BENZ SPRINTER 906 (C230) TIMING CHAIN
304		002 830 5708 BZ290BK-BLM1	BENZ SPRINTER 906 BLOWER MOTOR



BEN-YA INDUSTRIAL CO., LTD.

4F, NO.16, LANE 181, SEC.2, JIUZONG ROAD Taipei, Taiwan, R. O. C.

TEL: 886-2-27990822 FAX: 886-2-27978753 e-mail: benya@ms24.hinet.net

MERCEDES BENZ CATALOGUE

Date: 2022/08/30

SEQ.	PHOTO	OEM_NO/ITEM_NO	DESCRIPTION
305		001 830 5608 BZ290BK-BLM0	BENZ SPRINTER 906 BLOWER MOTOR
306		2E0 906 206G BZ290BK-BSR0	BENZ SPRINTER 906 BRAKE SENSOR
307		639 540 1417 BZ290BK-BSR2	BENZ SPRINTER 906 BRAKE SENSOR
308		906 540 1517 BZ290BK-BSR1	BENZ SPRINTER 906 BRAKE SENSOR
309		906 410 0381 BZ290BK-CBA0	BENZ SPRINTER 906 CENTER BEARING ASSY (PORPSHAFT MOUNTING)
310		272 052 0016 BZ290BK-CGE0	BENZ SPRINTER 906 CHAIN GUIDE RAIL
311		611 052 0016 BZ290BK-CGE1	BENZ SPRINTER 906 CHAIN GUIDE RAIL
312		906 330 4007 BZ290BK-CTAD	BENZ SPRINTER 906 CONTROL ARM LEFT



BEN-YA INDUSTRIAL CO., LTD.

4F, NO.16, LANE 181, SEC.2, JIUZONG ROAD Taipei, Taiwan, R.O.C.

TEL: 886-2-27990822 FAX: 886-2-27978753 e-mail: benya@ms24.hinet.net

MERCEDES BENZ CATALOGUE

Date: 2022/08/30

SEQ.	PHOTO	OEM_NO/ITEM_NO	DESCRIPTION
313		611 052 0416 BZ290BK-CGE3	BENZ SPRINTER 906 E320 CHAIN GUIDE
314		906 460 0055 BZ290BK-TRD0	BENZ SPRINTER 906 INNER TIE ROD AXLE JOINT
315		9067600347 BZ290BK-ROG0	BENZ SPRINTER 906 MIDDLE ROLLER GUIDE SLIDING DOOR
316		642 180 0009 BZ290BK-OFR3	BENZ SPRINTER 906 OIL FILTER
317		000 180 2609 BZ290BK-OFR2	BENZ SPRINTER 906 OIL FILTER
318		000 180 2309 BZ290BK-OFR1	BENZ SPRINTER 906 OIL FILTER
319		906 320 1789 BZ290BK-SLK1	BENZ SPRINTER 906 STEER LINK FRONT (stabilizer bar)
320		003 997 7594 BZ290BK-TCN1	BENZ SPRINTER 906 TIMING CHAIN (DUPLX)



BEN-YA INDUSTRIAL CO., LTD.

4F, NO.16, LANE 181, SEC.2, JIUZONG ROAD Taipei, Taiwan, R. O. C.

TEL: 886-2-27990822 FAX: 886-2-27978753 e-mail: benya@ms24.hinet.net

MERCEDES BENZ CATALOGUE

Date: 2022/08/30

SEQ.	PHOTO	OEM_NO/ITEM_NO	DESCRIPTION
321		272 050 0111 BZ290BK-CHT1	BENZ SPRINTER 906 TIMING CHAIN TENSIONER (CHAIN ADJUSTE)
322		640 050 0311 BZ290BK-CHT0	BENZ SPRINTER 906 TIMING CHAIN TENSIONER (CHAIN ADJUSTER)
323		906 997 1182 8PK2080	BENZ SPRINTER 906 V-RIBBED BELT
324		001 993 3996 6PK691	BENZ SPRINTER 906 V-RIBBED BELT
325		906 997 0792 8PK1480	BENZ SPRINTER 906 V-RIBBED BELT
326		014 997 0692 6PK2260	BENZ SPRINTER 906 V-RIBBED BELT
327		642 997 0292 7PK2035	BENZ SPRINTER 906 V-RIBBED BELT
328		001 421 1010 BZ290BK-BDPO	BENZ SPRINTER 906, VIANO VITO BRAKE DISC PAD



BEN-YA INDUSTRIAL CO., LTD.

4F, NO.16, LANE 181, SEC.2, JIUZONG ROAD Taipei, Taiwan, R.O.C.

TEL: 886-2-27990822 FAX: 886-2-27978753 e-mail: benya@ms24.hinet.net

MERCEDES BENZ CATALOGUE

Date: 2022/08/30

SEQ.	PHOTO	OEM_NO/ITEM_NO	DESCRIPTION
329		611 052 0216 BZ290BK-CGE2	BENZ SPRINTER 906, VITO (BUS) CHAIN GUIDE RAIL
330		6462000270 BZ290BK-TSB0	BENZ SPRINTER CDI TENSIONER BEARING
331		RT8016 BZ290BK-TSB2	BENZ SPRINTER CDI TENSIONER BEARING
332		2005822 BZ290BK-FCH0	BENZ SPRINTER EURO 3 FAN CLUTCH
333		A0002009723 BZ290BK-FCH1	BENZ SPRINTER EURO 5 FAN CLUTCH
334		901 501 0701 BZ290BK-ITC0	BENZ SPRINTER OM612 INTER COOLER
335		765155-0007 BZ290BK-TCA1	BENZ SPRINTER OM642 3.0LCDI TURBO CHARGER ASSY
336		651 180 0109 BZ290BK-OFR4	BENZ SPRINTER OM651 OIL FILTER



BEN-YA INDUSTRIAL CO., LTD.

4F, NO.16, LANE 181, SEC.2, JIUZONG ROAD Taipei, Taiwan, R.O.C.

TEL: 886-2-27990822 FAX: 886-2-27978753 e-mail: benya@ms24.hinet.net

MERCEDES BENZ CATALOGUE

Date: 2022/08/30

SEQ.	PHOTO	OEM_NO/ITEM_NO	DESCRIPTION
337		6510500016 BZ290BK-CGE4	BENZ SPRINTER TIMING CHAIN GUIDE
338		A0005450527 BZ290BK-RGL0	BENZ SPRINTER VACUUM PRESSURE CONVERTER VALVE PRESSURE REGULATOR
339		ENT410008 BZ290BK-RK10	BENZ SPRINTER VAN DIESEL VACUUM PUMP REPAIR KIT
340		901 760 1361 BZ290BK-DOH0	BENZ SPRINTER VITO 901 DOOR HANDLE
341		9013202030 BZ419BK-SAR0	BENZ SPRINTER, 412, 413 SHOCK ABSORBER
342		0000903851 BZ290BK-AFR0	BENZ SPRINTER, VITO/VIANO AIR FILTER
343		611200270 BZ290BK-TSB1	BENZ SPRINTER/ACCELO CDI TENSIONER BEARING
344		1932089 BZ290BK-FAN0	BENZ SPRINTER/RANGER FAN



BEN-YA INDUSTRIAL CO., LTD.

4F, NO.16, LANE 181, SEC.2, JIUZONG ROAD Taipei, Taiwan, R.O.C.

TEL: 886-2-27990822 FAX: 886-2-27978753 e-mail: benya@ms24.hinet.net

MERCEDES BENZ CATALOGUE

Date: 2022/08/30

SEQ.	PHOTO	OEM_NO/ITEM_NO	DESCRIPTION
345		0024706894 BZF79BK-UDP0	BENZ SPRINTER2500, 3500 UREA DOSING PUMP
346		BZ058BK-IGS3	BENZ SWF 911 IGNITION SWITCH
347		090346 BZ648BK-RK20	BENZ T8A (DJ5T) TD ROCKER ARM
348		BT-005 BZ121BK-WBT0	BENZ TRAILER WHEEL BOLT & NUT
349		2720100631 BZC31BK-OFR0	BENZ V6 2.5L 3.0L C230 C280 E350 E550 OIL SEPERATOR COVER
350		2710500800 BZ731BK-CSG0	BENZ W203 C203 CAMSHAFT GEAR (CAM PHASER) INTAKE
351		2710500900 BZ731BK-CSG1	BENZ W203 C230 CAMSHAFT GEAR (CAM PHASER) EXHAUST
352		2720505247 BZ731BK-CSG2	BENZ W203 CAMSHAFT GEAR (CAM PHASER) INTAKE, LEFT



BEN-YA INDUSTRIAL CO., LTD.

4F, NO.16, LANE 181, SEC.2, JIUZONG ROAD Taipei, Taiwan, R.O.C.

TEL: 886-2-27990822 FAX: 886-2-27978753 e-mail: benya@ms24.hinet.net

MERCEDES BENZ CATALOGUE

Date: 2022/08/30

SEQ.	PHOTO	OEM_NO/ITEM_NO	DESCRIPTION
353		2720505347 BZ731BK-CSG3	BENZ W203 CAMSHAFT GEAR (CAM PHASER), RIGHT
354		272 200 09 01 BZ731BK-WP0	BENZ W203 W204 WATER PUMP ASSEMBLY
355		271 200 02 01 BZ825BK-WP0	BENZ W203 W211 WATER PUMP
356		2720506847 BZH49BK-CSG0	BENZ W204 W203 C300 ML350 CAMSHAFT GEAR (CAM PHASER) EXHAUST
357		0008910305 BZH10BK-SAR0	BENZ W221 SHOCK ABSORBER
358		000 464 0604 BZK42BK-HFR0	BENZ W328, W343, W349 HYD. FILTER
359		1040501225 BZB24BK-HVL0	BENZ/VOLKSWAGEN 1.8L 16 VALVE ENGINE 111.920 HYD. VALVE LIFTER
360		05080060AB F4655109	BMW/BENZ/CHRYSLER/INA VALVE LIFTER



BEN-YA INDUSTRIAL CO., LTD.

4F, NO.16, LANE 181, SEC.2, JIUZONG ROAD Taipei, Taiwan, R.O.C.

TEL: 886-2-27990822 FAX: 886-2-27978753 e-mail: benya@ms24.hinet.net

MERCEDES BENZ CATALOGUE

Date: 2022/08/30

SEQ.	PHOTO	OEM_NO/ITEM_NO	DESCRIPTION
361		22231-4A001 11332247722	BMW/HYUNDAI/LANDROVER/BENZ/MINI/ROVER VALVE LIFTER
362		611-050-00-25 11321748881	BMW/PORSCHE/MERCEDES BENZ VALVE LIFTER
363		1 418 325 032 1 418 325 032	BOMAG / KHD / MAGIRUS-DEUTZ / MAN / MERCEDES-BENZ PLUNGER
364		6420500133 CS290BK-RK20	CHRYSLER/MERCEDES BENZ/SMART/MITSUBISHI SPRINTER ROCKER ARM
365		A613 820 01 61	HEAD LAMP 392*170*225 FOR BENZ/ GOLDEN DRAGON
366		A613 820 00 61+A613 820 01 61	HEAD LAMP 392*170*225 FOR BENZ/GOLDEN DRAGON
367		A613 820 00 61	HEAD LAMP 392*170*225 FOR BENZ/GOLDEN DRAGON
368		4030501436 51042027002	MAN/MERCEDES BENZ ROCKER ARM





BEN-YA INDUSTRIAL CO., LTD.

4F, NO.16, LANE 181, SEC.2, JIUZONG ROAD Taipei, Taiwan, R. O. C.

TEL: 886-2-27990822 FAX: 886-2-27978753 e-mail: benya@ms24.hinet.net

MERCEDES BENZ CATALOGUE

Date: 2022/08/30

SEQ.	PHOTO	OEM_NO/ITEM_NO	DESCRIPTION
369		2710301520 BZB86BK-CR00	MERC. BENZ M271.820 CON ROD
370		A2710306217 BZB86BK-PTN0	MERC. BENZ M271.820 PISTON WITH PIN STD
371		A0004297224	MERCEDE BENZ ACHS MODULATOR
372		A9362002670	MERCEDE BENZ BELT TENSIONER
373		A9362002170	MERCEDE BENZ BELT TENSIONER
374		A4722020919	MERCEDE BENZ PULLEY
375		A6443260200	MERCEDE BENZ SHOCK ABSORBER
376		A6283262900	MERCEDE BENZ SHOCK ABSORBER





BEN-YA INDUSTRIAL CO., LTD.

4F, NO.16, LANE 181, SEC.2, JIUZONG ROAD Taipei, Taiwan, R.O.C.

TEL: 886-2-27990822 FAX: 886-2-27978753 e-mail: benya@ms24.hinet.net

MERCEDES BENZ CATALOGUE

Date: 2022/08/30

SEQ.	PHOTO	OEM_NO/ITEM_NO	DESCRIPTION
377		6954230610	MERCEDES
378		6954230710	MERCEDES
379		1120160221	MERCEDES BENZ M 112.910 VALVE COVER GASKET
380		1120160321	MERCEDES BENZ M 112.910 VALVE COVER GASKET
381		A0009979207 16-000190402	MERCEDES O-RING
382		A0009977107 16-000190403	MERCEDES O-RING
383		A0009978303 16-000190405	MERCEDES O-RING
384		A0009977503 16-000190406	MERCEDES O-RING



BEN-YA INDUSTRIAL CO., LTD.

4F, NO.16, LANE 181, SEC.2, JIUZONG ROAD Taipei, Taiwan, R. O. C.

TEL: 886-2-27990822 FAX: 886-2-27978753 e-mail: benya@ms24.hinet.net

MERCEDES BENZ CATALOGUE

Date: 2022/08/30

SEQ.	PHOTO	OEM_NO/ITEM_NO	DESCRIPTION
385		A0299971445 16-000190410	MERCEDES O-RING
386		A0289974745 16-000190408	MERCEDES O-RING
387		A0289973545 16-000190412	MERCEDES O-RING
388		0281002456 0281002456	MERCEDES / CUMMINS INTAKE MANIFOLD PRESSURE SENSOR
389		A9064210400	MERCEDES 906 BRAKE PAD
390		A0044206920	MERCEDES 906 BRAKE PAD
391		943 545 0107	MERCEDES A/C SWITCH
392		A0105429417 0105429417	MERCEDES ABS SENSOR



BEN-YA INDUSTRIAL CO., LTD.

4F, NO.16, LANE 181, SEC.2, JIUZONG ROAD Taipei, Taiwan, R.O.C.

TEL: 886-2-27990822 FAX: 886-2-27978753 e-mail: benya@ms24.hinet.net

MERCEDES BENZ CATALOGUE

Date: 2022/08/30

SEQ.	PHOTO	OEM_NO/ITEM_NO	DESCRIPTION
393		943 460 0049	MERCEDES AIR BAG CLOCK SPRING
394		0004292097	MERCEDES AIR DRYER CARTRIDGE (with filter paper)
395		0124555065	MERCEDES ALTERNATOR
396		BZB83BK-CBK0	MERCEDES BENZ OM924 CYLINDER BLOCK
397		1130500034 1130500034	MERCEDES BENZ ROCKER ARM
398		1130500534 1130500534	MERCEDES BENZ ROCKER ARM
399		1660500335 1660500335	MERCEDES BENZ ROCKER ARM
400		1020550501 1020550501	MERCEDES BENZ ROCKER ARM









BEN-YA INDUSTRIAL CO., LTD.

4F, NO.16, LANE 181, SEC.2, JIUZONG ROAD Taipei, Taiwan, R. O. C.

TEL: 886-2-27990822 FAX: 886-2-27978753 e-mail: benya@ms24.hinet.net

MERCEDES BENZ CATALOGUE

Date: 2022/08/30

SEQ.	PHOTO	OEM_NO/ITEM_NO	DESCRIPTION
401		6010500325 6010500080	MERCEDES BENZ VALVE LIFTER
402		14450-00QAC A6260960168	MERCEDES BENZ / NISSAN TURBO GASKET
403		144157606R A6070960080	MERCEDES BENZ / RENAULT / NISSAN TURBO GASKET
404		A0071530928 A0071530928	MERCEDES BENZ A CLASS, B CLASS EXHAUST GAS TEMP. SENSOR
405		0071539128 A0071539128	MERCEDES BENZ A CLASS, B CLASS, E CLASS EXHAUST GAS TEMP. SENSOR
406		059906088BK 059906088BK	MERCEDES BENZ A6, A7, A8 EXHAUST GAS TEMP. SENSOR
407		007 542 7218	MERCEDES BENZ ABS SENSOR FRONT
408		007 542 2118	MERCEDES BENZ ABS SENSOR REAR L



BEN-YA INDUSTRIAL CO., LTD.

4F, NO.16, LANE 181, SEC.2, JIUZONG ROAD Taipei, Taiwan, R.O.C.

TEL: 886-2-27990822 FAX: 886-2-27978753 e-mail: benya@ms24.hinet.net

MERCEDES BENZ CATALOGUE

Date: 2022/08/30

SEQ.	PHOTO	OEM_NO/ITEM_NO	DESCRIPTION
409		007 542 2018	MERCEDES BENZ ABS SENSOR REAR R
410		6680500233 BZO12BK-RK20	MERCEDES BENZ AE FOL162 ROCKER ARM
411		0025404417	MERCEDES BENZ BUS OIL LEVEL SENSOR
412		0019050700 A0019050700	MERCEDES BENZ C CLASS, E CLASS, CLS, SLK EXHAUST GAS TEMP. SENSOR
413		A0051531128 A0051531128	MERCEDES BENZ C, CLK, M, GL CLASS EXHAUST GAS TEMP. SENSOR
414		6400 500 111 6400500111	MERCEDES BENZ CHAIN TENSIONER
415		271 050 06 11 2710500611	MERCEDES BENZ CHAIN TENSIONER
416		1110500411 1110500411	MERCEDES BENZ CHAIN TENSIONER





BEN-YA INDUSTRIAL CO., LTD.

4F, NO.16, LANE 181, SEC.2, JIUZONG ROAD Taipei, Taiwan, R.O.C.

TEL: 886-2-27990822 FAX: 886-2-27978753 e-mail: benya@ms24.hinet.net

MERCEDES BENZ CATALOGUE

Date: 2022/08/30

SEQ.	PHOTO	OEM_NO/ITEM_NO	DESCRIPTION
417		A0071536628 0071536628	MERCEDES BENZ CLS, S CLASS, R CLASS, SPRINTER 3-T BUS EXHAUST GAS TEMP. SENSOR
418		1882 166 707 BZ058BK-CCR0	MERCEDES BENZ CLUTCH COVER 380MM
419		1861 715 032 BZ058BK-CP10	MERCEDES BENZ CLUTCH PLATE
420		1161300160	MERCEDES BENZ DEFLECTION / GUIDE PULLEY
421		A0051534028 A0051534028	MERCEDES BENZ E CLASS, S CLASS EXHAUST GAS TEMP. SENSOR
422		A0081534028 A0081534028	MERCEDES BENZ E CLASS, S CLASS EXHAUST GAS TEMP. SENSOR
423		A0009059000 0009059000	MERCEDES BENZ E CLASS, S CLASS, M CLASS, CLS EXHAUST GAS TEMP. SENSOR
424		1190500825 BZ016BK-HVL0	MERCEDES BENZ E320 HYD. VALVE LIFTER



BEN-YA INDUSTRIAL CO., LTD.

4F, NO.16, LANE 181, SEC.2, JIUZONG ROAD Taipei, Taiwan, R.O.C.

TEL: 886-2-27990822 FAX: 886-2-27978753 e-mail: benya@ms24.hinet.net

MERCEDES BENZ CATALOGUE

Date: 2022/08/30

SEQ.	PHOTO	OEM_NO/ITEM_NO	DESCRIPTION
425		A2601420500	MERCEDES BENZ EX. MANIFOLD GASKET
426		2660110132 71-972206-00	MERCEDES BENZ FLYWHEEL SEAL (FKM)
427		0002609557	MERCEDES BENZ GEAR LEVER KNOB
428		9437500384	MERCEDES BENZ GRILL LOCK LH
429		9437500284	MERCEDES BENZ GRILL LOCK RH
430		960 820 0329	MERCEDES BENZ HEAD LIGHT LEFT
431		960 820 0339	MERCEDES BENZ HEAD LIGHT RIGHT
432		0005454104?	MERCEDES BENZ HEADLIGHT SWITCH



BEN-YA INDUSTRIAL CO., LTD.

4F, NO.16, LANE 181, SEC.2, JIUZONG ROAD Taipei, Taiwan, R.O.C.

TEL: 886-2-27990822 FAX: 886-2-27978753 e-mail: benya@ms24.hinet.net

MERCEDES BENZ CATALOGUE

Date: 2022/08/30

SEQ.	PHOTO	OEM_NO/ITEM_NO	DESCRIPTION
433		1020500633 BZ849BK-RK20	MERCEDES BENZ M102 ROCKER ARM
434		H977/5 BZ849BK-EB20A	MERCEDES BENZ M102/M111 OM601/OM604 ENGINE MAIN BEARING 0.25
435		H977/5 BZ849BK-EB10	MERCEDES BENZ M102/M111 OM601/OM604 ENGINE MAIN BEARING STD
436		H977/5 BZ849BK-EB20B	MERCEDES BENZ M102/M111 OM601/OM604 MAIN BEARING 0.50
437		1041011080	MERCEDES BENZ M104941 INLET MANIFOLD GASKET
438		A2700300060 BZB86BK-EB30	MERCEDES BENZ M271 CON ROD BEARING STD
439		BZB66BK-CMT0C	MERCEDES BENZ M611 CAMSHAFT without gear (chilled)
440		5410501236 BZI99BK-RK20	MERCEDES BENZ MP2/MP3 ROCKER ARM



BEN-YA INDUSTRIAL CO., LTD.

4F, NO.16, LANE 181, SEC.2, JIUZONG ROAD Taipei, Taiwan, R.O.C.

TEL: 886-2-27990822 FAX: 886-2-27978753 e-mail: benya@ms24.hinet.net

MERCEDES BENZ CATALOGUE

Date: 2022/08/30

SEQ.	PHOTO	OEM_NO/ITEM_NO	DESCRIPTION
441		A0091530728 A0101532328	MERCEDES BENZ NOX SENSOR
442		0061537328	MERCEDES BENZ NOX SENSOR
443		A0065427218	MERCEDES BENZ NOX SENSOR
444		A0009050426	MERCEDES BENZ NOX SENSOR
445		A0009053403	MERCEDES BENZ NOX SENSOR
446		A0009057000	MERCEDES BENZ NOX SENSOR
447		5WK96682B A0009053503	MERCEDES BENZ NOX SENSOR
448		A0009052900 A0009053603	MERCEDES BENZ NOX SENSOR



BEN-YA INDUSTRIAL CO., LTD.

4F, NO.16, LANE 181, SEC.2, JIUZONG ROAD Taipei, Taiwan, R.O.C.

TEL: 886-2-27990822 FAX: 886-2-27978753 e-mail: benya@ms24.hinet.net

MERCEDES BENZ CATALOGUE

Date: 2022/08/30

SEQ.	PHOTO	OEM_NO/ITEM_NO	DESCRIPTION
449		5WK96683A A0009057100	MERCEDES BENZ NOX SENSOR
450		A0009059803	MERCEDES BENZ NOX SENSOR
451		A0009055100	MERCEDES BENZ NOX SENSOR
452		6345010001 BZO34BK-RDT0	MERCEDES BENZ OH 1830 RADIATOR
453		271 050 01 16 BZB86BK-CGE0	MERCEDES BENZ OM271 CHAIN GUIDE
454		2710521616 BZB86BK-CGE2	MERCEDES BENZ OM271 CHAIN GUIDE
455		2710521516 BZB86BK-CGE1	MERCEDES BENZ OM271 CHAIN GUIDE
456		01-3584 BZ847BK-EB30	MERCEDES BENZ OM602 CON ROD BEARING STD



BEN-YA INDUSTRIAL CO., LTD.

4F, NO.16, LANE 181, SEC.2, JIUZONG ROAD Taipei, Taiwan, R.O.C.

TEL: 886-2-27990822 FAX: 886-2-27978753 e-mail: benya@ms24.hinet.net

MERCEDES BENZ CATALOGUE

Date: 2022/08/30

SEQ.	PHOTO	OEM_NO/ITEM_NO	DESCRIPTION
457		H997/6 BZ847BK-EB10	MERCEDES BENZ OM602/605 ENGINE MAIN BEARING STD
458		H997/6 BZ847BK-EB20A	MERCEDES BENZ OM602/605 MAIN BEARING 0.25
459		611 010 4420 BZB66BK-CLH0	MERCEDES BENZ OM611 CYLINDER HEAD
460		01-3040/4 BZ793BK-EB30	MERCEDES BENZ OM616/OM617 UNI MOG C/R BEARING STD
461		646 010 1420 BZH75BK-CLH0	MERCEDES BENZ OM646 CYLINDER HEAD
462		6510500033 BZF59BK-RK20	MERCEDES BENZ OM651 ROCKER ARM
463		9040301002 BZB83BK-CKS0F	MERCEDES BENZ OM904 CRANKSHAFT FORGED
464		904 010 78 05 BZB83BK-CBK1	MERCEDES BENZ OM904 CYLINDER BLOCK



BEN-YA INDUSTRIAL CO., LTD.

4F, NO.16, LANE 181, SEC.2, JIUZONG ROAD Taipei, Taiwan, R. O. C.

TEL: 886-2-27990822 FAX: 886-2-27978753 e-mail: benya@ms24.hinet.net

MERCEDES BENZ CATALOGUE

Date: 2022/08/30

SEQ.	PHOTO	OEM_NO/ITEM_NO	DESCRIPTION
465		72-3851 BZB22BK-EB10S	MERCEDES BENZ OM906 ENGINE MAIN BEARING STD SPUTTER
466		71-3850 BZB22BK-EB30S	MERCEDES BENZ OM906 CON ROD BEARING STD SPUTTER
467		BZB22BK-CKS0	MERCEDES BENZ OM906 CRANKSHAFT
468		906 050 0901 BZB22BK-CKS0F	MERCEDES BENZ OM906 CRANKSHAFT forged
469		906 030 1302 BZB22BK-CKSF	MERCEDES BENZ OM906 CRANKSHAFT forged
470		906 010 04 06 BZB22BK-CBK0	MERCEDES BENZ OM906 CYLINDER BLOCK
471		9240160720 BZL58BK-GT30	MERCEDES BENZ OM924 CYL HEAD GASKET (107.5mm)
472		BZL59BK-ENGO	MERCEDES BENZ OM926LA ENGINE ASSEMBLY



BEN-YA INDUSTRIAL CO., LTD.

4F, NO.16, LANE 181, SEC.2, JIUZONG ROAD Taipei, Taiwan, R.O.C.

TEL: 886-2-27990822 FAX: 886-2-27978753 e-mail: benya@ms24.hinet.net

MERCEDES BENZ CATALOGUE

Date: 2022/08/30

SEQ.	PHOTO	OEM_NO/ITEM_NO	DESCRIPTION
473		000 460 6780 000 460 6780	MERCEDES BENZ POWER STEERING PUMP
474		960 500 1454	MERCEDES BENZ RADIATOR A/C
475		A0001544716 0001544716	MERCEDES BENZ RECTIFIER
476		000 154 3805	MERCEDES BENZ REGULATOR
477		15300420610	MERCEDES BENZ RETARDER REPAIR KIT
478		A0005427218	MERCEDES BENZ Sensor Nox
479		A0009052900	MERCEDES BENZ Sensor Nox
480		A001530004 A001530122	MERCEDES BENZ Sensor Nox







BEN-YA INDUSTRIAL CO., LTD.

4F, NO.16, LANE 181, SEC.2, JIUZONG ROAD Taipei, Taiwan, R. O. C.

TEL: 886-2-27990822 FAX: 886-2-27978753 e-mail: benya@ms24.hinet.net

MERCEDES BENZ CATALOGUE

Date: 2022/08/30

SEQ.	PHOTO	OEM_NO/ITEM_NO	DESCRIPTION
481		1601420880 BZC55BK-GT60	MERCEDES BENZ SMART MANIFOLD GASKET EXHAUST
482		A660 997 0094 BZC55BK-TMK1	MERCEDES BENZ SMART 1.3 TIMING KIT
483		A160 997 0494 BZC55BK-TMK0	MERCEDES BENZ SMART 1.3 TIMING KIT
484		0071536628 A0071536628	MERCEDES BENZ SPRINTER 3-T BUS EXHAUST GAS TEMP. SENSOR
485		0061512201/80 0061512201/80	MERCEDES BENZ STARTER
486		940 460 3500 940 460 3300	MERCEDES BENZ STEERING GEARBOX
487		6674620430	MERCEDES BENZ STEERING LOCK
488		0071537528 A0071537528	MERCEDES BENZ T MODEL, E CLASS, M CLASS, S CLASS, R CLASS, SPRINTER 3-T BUS EXHAUST GAS TEMP. SENSOR



BEN-YA INDUSTRIAL CO., LTD.

4F, NO.16, LANE 181, SEC.2, JIUZONG ROAD Taipei, Taiwan, R. O. C.

TEL: 886-2-27990822 FAX: 886-2-27978753 e-mail: benya@ms24.hinet.net

MERCEDES BENZ CATALOGUE

Date: 2022/08/30

SEQ.	PHOTO	OEM_NO/ITEM_NO	DESCRIPTION
489		002 542 73 17 BZ058BK-TS10	MERCEDES BENZ TEMPERATURE SWITCH
490		8510100E 1130500380	MERCEDES BENZ VALVE LIFTER
491		2711560090 A2711560090	MERCEDES BENZ VARIABLE VALVE TIMING SOLENOID
492		2720510177 A2720510177	MERCEDES BENZ VARIABLE VALVE TIMING SOLENOID
493		0009053300 0009053300	MERCEDES BENZ VITO, SPRINTER EXHAUST GAS TEMP. SENSOR
494		1020550301 B003BK-RK20	MERCEDES BENZ W201/W124/S124 T1 ROCKER ARM
495		940 350 10 35	MERCEDES BENZ WHEEL HUB SEAL KIT
496		9737200346	MERCEDES BENZ WINDOW LIFTER (L)



BEN-YA INDUSTRIAL CO., LTD.

4F, NO.16, LANE 181, SEC.2, JIUZONG ROAD Taipei, Taiwan, R. O. C.

TEL: 886-2-27990822 FAX: 886-2-27978753 e-mail: benya@ms24.hinet.net

MERCEDES BENZ CATALOGUE

Date: 2022/08/30

SEQ.	PHOTO	OEM_NO/ITEM_NO	DESCRIPTION
497		9737200446	MERCEDES BENZ WINDOW LIFTER (R)
498		A0054202320	MERCEDES BRAKE PAD
499		6952507104 135020711	MERCEDES CLUTCH COVER
500		1882 305 132 1882 305 132	MERCEDES CLUTCH COVER 310mm
501		3482 012 240 3482 012 240	MERCEDES CLUTCH COVER 330mm
502		3482 017 033 3482 017 033	MERCEDES CLUTCH COVER 380mm
503		1882 166 737 BZ058BK-CCR1	MERCEDES CLUTCH COVER 380mm
504		3817660801	MERCEDES DOOR HANDLE







BEN-YA INDUSTRIAL CO., LTD.

4F, NO.16, LANE 181, SEC.2, JIUZONG ROAD Taipei, Taiwan, R.O.C.

TEL: 886-2-27990822 FAX: 886-2-27978753 e-mail: benya@ms24.hinet.net

MERCEDES BENZ CATALOGUE

Date: 2022/08/30

SEQ.	PHOTO	OEM_NO/ITEM_NO	DESCRIPTION
505		960 723 0609	MERCEDES DOOR HANDLE LEFT
506		960 723 1709	MERCEDES DOOR HANDLE RIGHT
507		0135427317	MERCEDES FUEL TANK LEVEL SENSOR
508		0135427117	MERCEDES FUEL TANK LEVEL SENSOR
509		0135420218	MERCEDES FUEL TANK LEVEL SENSOR
510		A0024204920	MERCEDES GDB5067
511		0009883260 0009881760	MERCEDES IGNITION SWITCH
512		000 544 7211	MERCEDES INDICATOR LIGHT



BEN-YA INDUSTRIAL CO., LTD.

4F, NO.16, LANE 181, SEC.2, JIUZONG ROAD Taipei, Taiwan, R.O.C.

TEL: 886-2-27990822 FAX: 886-2-27978753 e-mail: benya@ms24.hinet.net

MERCEDES BENZ CATALOGUE

Date: 2022/08/30

SEQ.	PHOTO	OEM_NO/ITEM_NO	DESCRIPTION
513		6243560080	MERCEDES SHAFT OIL SEAL KIT
514		0081532228 A0081532228	MERCEDES SPRINTER, VIANO, VITO, A-CLASS, B CLASS, S CLASS EXHAUST GAS TEMP. SENSOR
515		943 545 0124	MERCEDES SWITCH
516		943 545 0707	MERCEDES SWITCH
517		0055451713	MERCEDES SWITCH
518		0045455113	MERCEDES SWITCH
519		0035454514	MERCEDES SWITCH
520		0000960115 0000960115	Mercedes Unimog Turbocharger fan blade



BEN-YA INDUSTRIAL CO., LTD.

4F, NO.16, LANE 181, SEC.2, JIUZONG ROAD Taipei, Taiwan, R.O.C.

TEL: 886-2-27990822 FAX: 886-2-27978753 e-mail: benya@ms24.hinet.net

MERCEDES BENZ CATALOGUE

Date: 2022/08/30

SEQ.	PHOTO	OEM_NO/ITEM_NO	DESCRIPTION
521		XPB1500 0039970092	MERCEDES V BELT
522		3829970392	MERCEDES V BELT
523		0051538028 A0051538028	MERCEDES W211 W203 200 220 CDI EXHAUST GAS TEMP. SENSOR
524		9040300040S1	MERCEDES-BENZ MAIN BEARING KIT
525		0002300410 BZH19BK-ATN0	MERCEDES-BENZ BELT TENSIONER
526		0002300410 BZH19BK-ATNP	MERCEDES-BENZ BELT TENSIONER PULLEY
527		0002300410 BZH19BK-ATNS	MERCEDES-BENZ BELT TENSIONER SPRING
528		0002300410 BZH19BK-ATNSP	MERCEDES-BENZ BELT TENSIONER SPRING + PULLEY







BEN-YA INDUSTRIAL CO., LTD.

4F, NO.16, LANE 181, SEC.2, JIUZONG ROAD Taipei, Taiwan, R. O. C.

TEL: 886-2-27990822 FAX: 886-2-27978753 e-mail: benya@ms24.hinet.net

MERCEDES BENZ CATALOGUE

Date: 2022/08/30

SEQ.	PHOTO	OEM_NO/ITEM_NO	DESCRIPTION
529		0002001570	MERCEDES-BENZ BELT TENSIONER
530		A0015454709 A0015454709	MERCEDES-BENZ BREAKING LIGHT SWITCH
531		A0015458409 A0015458409	MERCEDES-BENZ BREAKING LIGHT SWITCH
532		0019050600 A0019050600	Mercedes-Benz C-Class 2007 W204 EXHAUST GAS TEMP. SENSOR
533		0051531028 A0051531028	MERCEDES-BENZ C-CLASS, SPRINTER 3-T BUS EXHAUST GAS TEMP. SENSOR
534		A0009055202 A0009055202	Mercedes-Benz E-CLASS 2009 2.2L EXHAUST GAS TEMP. SENSOR
535		A0051532228 A0051532228	MERCEDES-BENZ E-CLASS, C CLASS, R CLASS, M CLASS EXHAUST GAS TEMP. SENSOR
536		0019052800 A0019052800	Mercedes-Benz E-Class/Saloon SaloonE 250 CDI 4matic 2143ccm 204HP 150KW EXHAUST GAS TEMP. SENSOR



BEN-YA INDUSTRIAL CO., LTD.

4F, NO.16, LANE 181, SEC.2, JIUZONG ROAD Taipei, Taiwan, R. O. C.

TEL: 886-2-27990822 FAX: 886-2-27978753 e-mail: benya@ms24.hinet.net

MERCEDES BENZ CATALOGUE

Date: 2022/08/30

SEQ.	PHOTO	OEM_NO/ITEM_NO	DESCRIPTION
537		0071538628 0071538628	MERCEDES-BENZ E-KLASSE W211 420 CDI EXHAUST GAS TEMP. SENSOR
538		0009058800 A0009058800	MERCEDES-BENZ EXHAUST GAS TEMP. SENSOR
539		A0000901551	MERCEDES-BENZ FUEL FILTER
540		A0071534328 A0071534328	MERCEDES-BENZ FUEL PRESSURE SENSOR
541		3140150622	MERCEDES-BENZ GASKET
542		20846003071	MERCEDES-BENZ GASKET
543		A0015451209 A0015451209	MERCEDES-BENZ GEARBOX REVERSE LIGHT SWITCH
544		A0025421717 A0025421717	MERCEDES-BENZ MAN OIL PRESSURE SENSOR



BEN-YA INDUSTRIAL CO., LTD.

4F, NO.16, LANE 181, SEC.2, JIUZONG ROAD Taipei, Taiwan, R. O. C.

TEL: 886-2-27990822 FAX: 886-2-27978753 e-mail: benya@ms24.hinet.net

MERCEDES BENZ CATALOGUE

Date: 2022/08/30

SEQ.	PHOTO	OEM_NO/ITEM_NO	DESCRIPTION
545		A0041531828 A0041531828	MERCEDES-BENZ MANIFOLD ABSOLUTE PRESSURE SENSOR
546		A0061534728 A0051536128	MERCEDES-BENZ Manifold Pressure Sensor
547		5WK96642B A0081539828	MERCEDES-BENZ NOX SENSOR
548		A4571840125 A0001802909	MERCEDES-BENZ OIL FILTER
549		A4001800212	MERCEDES-BENZ OIL FILTER
550		A9061840325ZGS A9061800209	MERCEDES-BENZ OIL FILTER
551		A4000920005	MERCEDES-BENZ OIL FILTER
552		A0125420517 A0125420517	MERCEDES-BENZ OIL PRESSURE SENSOR



BEN-YA INDUSTRIAL CO., LTD.

4F, NO.16, LANE 181, SEC.2, JIUZONG ROAD Taipei, Taiwan, R.O.C.

TEL: 886-2-27990822 FAX: 886-2-27978753 e-mail: benya@ms24.hinet.net

MERCEDES BENZ CATALOGUE

Date: 2022/08/30

SEQ.	PHOTO	OEM_NO/ITEM_NO	DESCRIPTION
553		0000182935	MERCEDES-BENZ OIL SEPPERATOR
554		000906030000	MERCEDES-BENZ PLUG, MACHINE THREAD
555		A0015421718 A0015421718	MERCEDES-BENZ PRESSURE SENSOR
556		6205000903 6205000903	Mercedes-Benz radiator
557		A0015457409 A0015457409	MERCEDES-BENZ REVERSE SENSOR
558		340804077011Z 340804077011Z	MERCEDES-BENZ RPM INDUCTIVE SPEED SENSOR
559		0019972641	MERCEDES-BENZ SEAL
560		0069978547	MERCEDES-BENZ SEAL



BEN-YA INDUSTRIAL CO., LTD.

4F, NO.16, LANE 181, SEC.2, JIUZONG ROAD Taipei, Taiwan, R. O. C.

TEL: 886-2-27990822 FAX: 886-2-27978753 e-mail: benya@ms24.hinet.net

MERCEDES BENZ CATALOGUE

Date: 2022/08/30

SEQ.	PHOTO	OEM_NO/ITEM_NO	DESCRIPTION
561		A0061534528 A0061534528	Mercedes-Benz Temperature Sensor
562		A0001400030 A0001400030	Mercedes-Benz Temperature Sensor
563		A0001539932 A0001539932	MERCEDES-BENZ UNIMOG OIL PRESSURE SWITCH
564		6110500801 6110500001	MERCEDES-BENZ, CAMSHAFT (SEMI-FINISHED ; DUCTILE)
565		0005001149 0005001149	MERCEDES-BENZ, Expansion tank
566		F4659209 1560500225	MERCEDES-BENZ/INA VAVLE LIFTER
567		0071539228 A0071539228	MERCEDES-BENZA-CLASS (W169) (2004/09 - 2012/06) MERCEDES-BENZB-CLASS (W245) (2005/03 - 2011/11 EXHAUST GAS TEMP. SENSOR
568		A000 820 49 64+A000 820 50 64	REAR LAMP W/FOG LAMP 580 FOR BENZ W/EMARK W/O BULB W/O SOCKET





BEN-YA INDUSTRIAL CO., LTD.

4F, NO.16, LANE 181, SEC.2, JIUZONG ROAD Taipei, Taiwan, R.O.C.

TEL: 886-2-27990822 FAX: 886-2-27978753 e-mail: benya@ms24.hinet.net

MERCEDES BENZ CATALOGUE

Date: 2022/08/30

SEQ.	PHOTO	OEM_NO/ITEM_NO	DESCRIPTION
569		130011597R RA489BK-CMT0	RENAULT / MERCEDES / GM CAMSHAFT (Steel C45)
570		130015174R RA489BK-CMT1	RENAULT / MERCEDES / GM CAMSHAFT (Steel C45)
571		0281002907 VWI88BK-RRS0	VOLKSWAGEN/BENZ/NISSAN DIESEL COMMON RAIL PRESSURE SENSOR